

# H-TEK XR

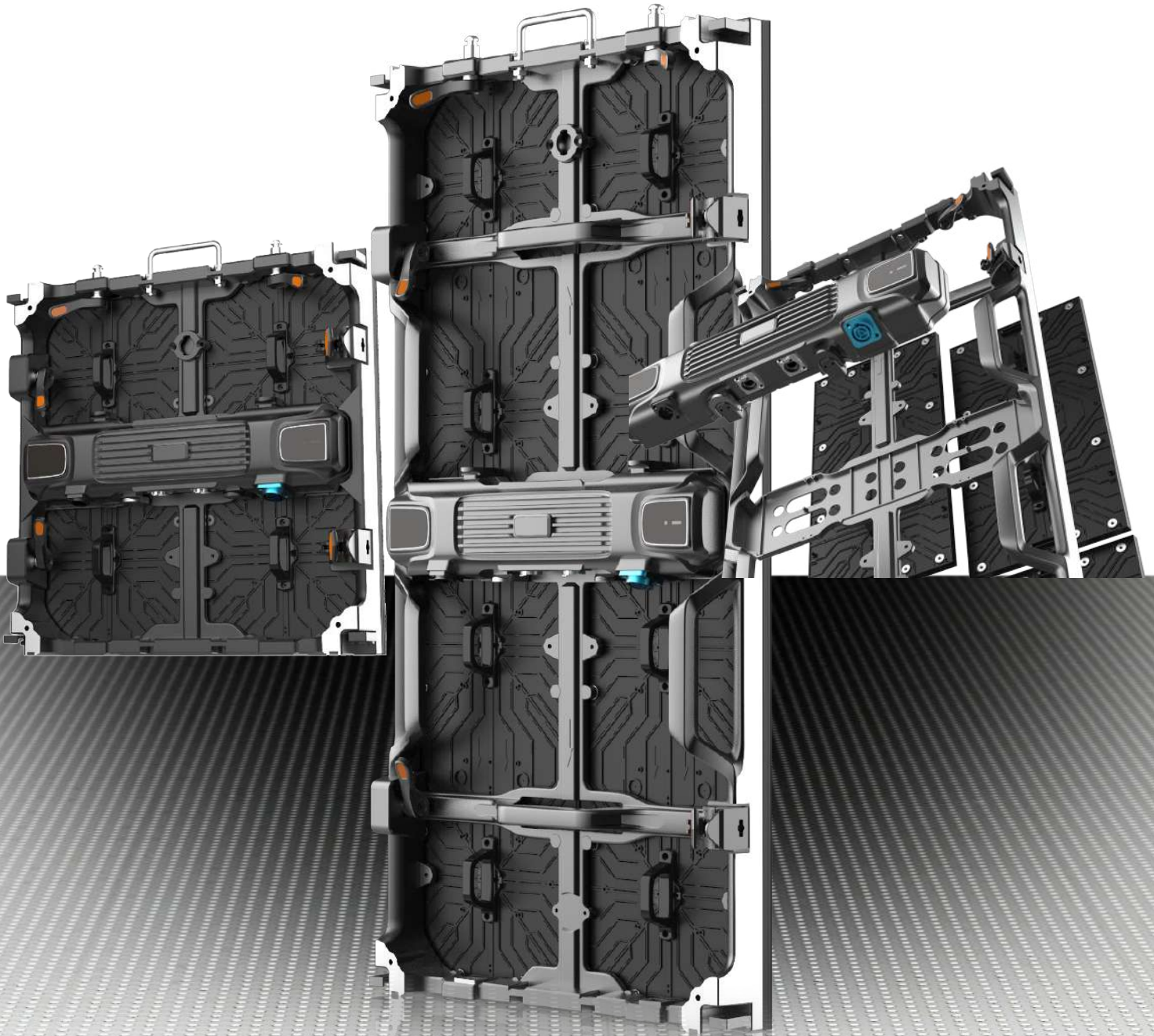

VERSATILE, CURVABLE & LIGHT FOR RENTAL & FIXED SCREENS





### Curvable

Convex and concave curving at +/- 10 degrees per panel.



### Lightweight

At 25kg/sqm, H-TEK XR is a perfect choice where weight limits are present for applications and installation needs to be quick and easy.



### Corner and Edge Protection

Corner protection for cabinets and LED tile PCBs eliminating the risks of collision damage.



### Rental & Fixed Installations

Suitable for both rental and fixed installations. Two chassis sizes available for fixed installation and standard 500 x 500mm rental panels available. Rental panels include convenient handles, quick lock mechanisms and PDUs containing all electronics, for easy installation.



### 5 Year Warranty

As with all digiLED Premium products, H-TEK XR comes with a 5 year warranty. Contact your local Service Lab via online RMA for our renowned fast turnaround.

- **H-TEK XR** features intelligent on-board flash memory, maintaining colour accuracy automatically.
- **H-TEK XR** features flexible and universal stacking and suspension accessories with digiLED H-TEK, X-TEK and X-TEK XR.
- **H-TEK XR** features a sealed PDU on the rear, protecting vulnerable control and power electronics from the ingress of particles and moisture.





**FEATURES**

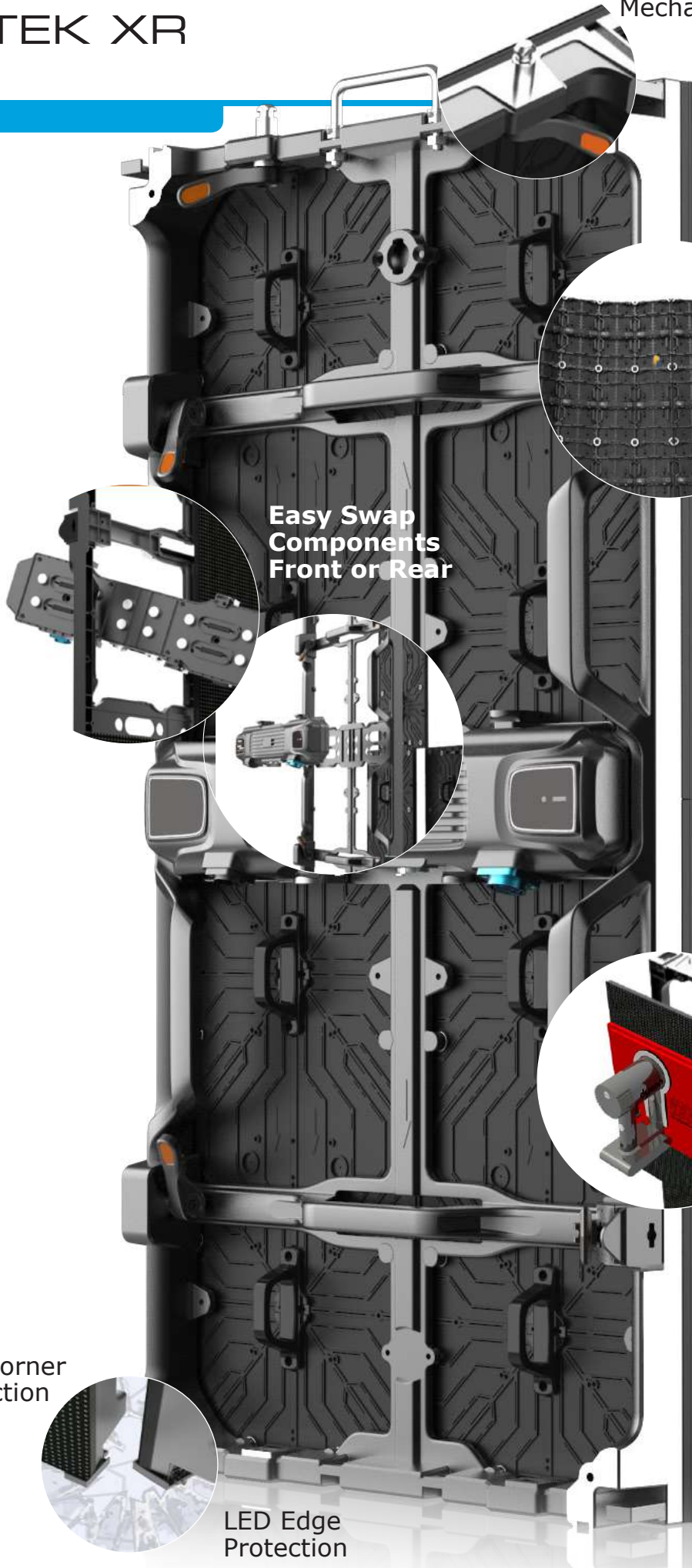

**Easy Swap  
Components  
Front or Rear**

**+/- 10 Degree  
Curving Control**

**dAVE 250  
Vacuum Tool For  
Quick and Easy  
LED Tile Removal**

**LED Corner  
Protection**

**LED Edge  
Protection**



500 x 500mm and 500 x 1000mm cabinets can be used for flexibility and convenience

500 x 500mm Cabinet



500 x 1000mm Cabinet





## SPECIFICATIONS

INDOOR		H-TEK XR 2600	H-TEK XR 2980	H-TEK XR 3910
Physical Pixel Pitch (HxV) mm		2.604	2.976	3.906
Pixel Resolution (Width/Height)	pixels/panel	192/384	168/336	128/256
Panel Dimensions	(W x H x D) mm	500 x 1000 x 85		
Optional Panel Dimensions	(W x H x D) mm	500 x 500 x 85		
Standard Panel Area	m <sup>2</sup>	0.5		
Standard Weight	kg/m <sup>2</sup>	34		
Ingress Protection	(Front/Rear)	Indoor IP40/IP40		
Minimum Curving Radius	degrees	3.0		
Corner Option Available	degrees	Yes (90)		
Maintenance Access		All Front and All Rear		
Standard Refresh Rate	Hz	≥2,880	≥2,880	≥1,920
Uncalibrated Brightness*	nits	≥1300	≥1300	≥1300
Calibrated Brightness*	nits	≥1100	≥1100	≥1100
Input Voltage	VAC/Hz	100~240/50-60		
Max Power Consumption**	W/sqm	550	520	520
Typical Working Power Consumption**	W/sqm	165	156	156
Operating Temperature (min/max)	degC	-10/+40		
Certification		CE (IEC82368-1 TBC), FCC, ETL, (EMC, LVD, RoHS): TBC		
HDR***		(see foot note)		

All specifications are subject to change without prior notification. E&OE.

Specifications are for standard system configuration. Contact your digiLED expert for detailed specification.

\*The figures shown for brightness are standard guideline figures only and based on average test laboratory conditions.

\*\* The figures shown for power consumption are standard guideline figures only and based on average test laboratory conditions.

\*\*\*HDR: Subject to system configuration and processing.

## PANEL INFORMATION

Front and Rear Servicing



Easy Component Swapping

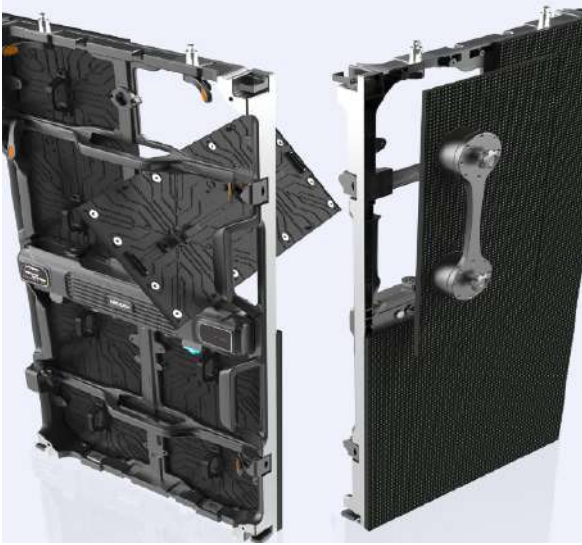

Edge Protection

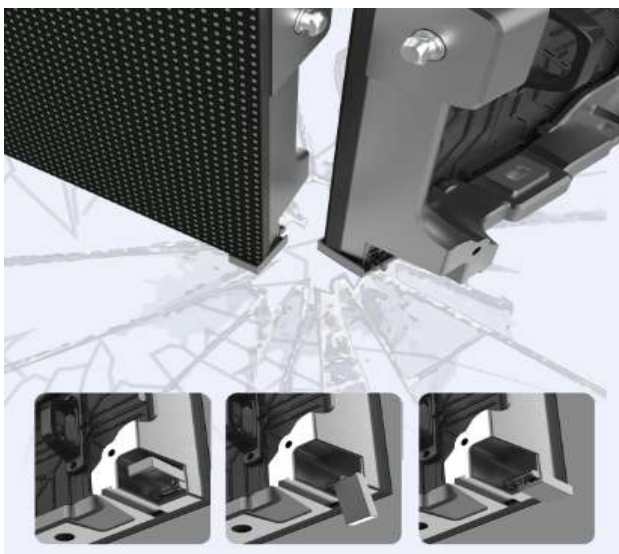

Concave and Convex Curving





INDOOR

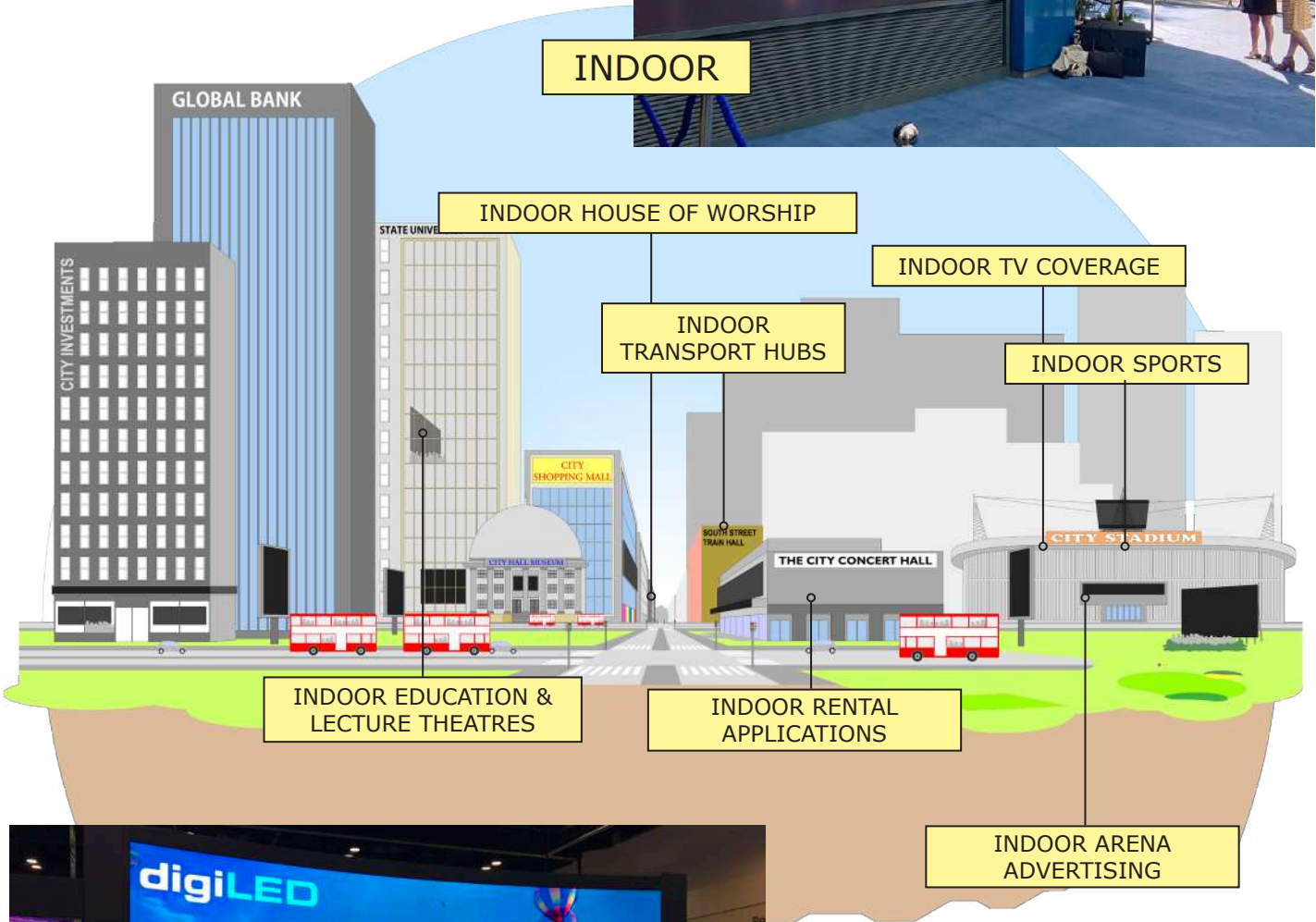



BUILT WITH PREMIUM COMPONENTS: THE HIGHEST GRADE PARTS THROUGHOUT



BACKED BY OUR OWN HIGHLY KNOWLEDGEABLE digiLED TECH HUB QC ENGINEERS, THE INDUSTRY'S LEADING QC TEAM



COMES WITH A 5 YEAR WARRANTY: TECH HUB SERVICES LOCATED in US, UK, ASIA and SOUTH AFRICA



INCLUDES AN ENHANCED & COMPREHENSIVE SPARES PACKAGE



AN APPRECIATION FOR QUALITY



BUILT IN TRUSTED, PREMIUM PARTNERS ASSEMBLY PLANTS: MONITORED AND QUALITY CONTROLLED BY digiLED TECH HUB ENGINEERS



SUBJECT TO A COMPREHENSIVE 228 STEP QC PROGRAMME FROM POINT OF ORDER RIGHT THROUGH TO HANDOVER



FULLY CERTIFIED: CE, UKCA, FCC, CCC, ETL, RoHS, LVD, EMC



OPTION: BUILT-IN digiLED's ZEUS POWER MANAGEMENT SYSTEM AT ADDITIONAL COST



### Our Ethos

Our goal is to do business with suppliers and customers whose company we enjoy and whose principles and values we respect.

We endeavour to be politely firm in our beliefs and steadfastly uphold our standards by doing the job correctly to produce quality products, supplied with loving care, to customers who cherish our systems and the enthusiastic, friendly expertise we strive to provide.

We love our work and are proud of our experience and our expertise. We want to do business with people who see the benefits of what we do and appreciate our input.

digiLEDers are keen to offer advice and an insight into our specialist knowledge without demanding a commercial return, if we can't convince customers of our value, we don't deserve their patronage.

### Our Products

Huge, bright, vibrant, bespoke digiLED screens are designed using premium components, by seasoned LED experts, then crafted and assembled in selected specialist factories.

Assembly, production and testing is monitored by the industry's leading QC team, using a proven 228-step manufacturing QC process, paying meticulous attention to fine detail.

The resulting digiLED screens exhibit superior images, providing reliable performance throughout the 5-year warranty period and beyond. Supported locally by experienced, qualified, field and bench engineers.

**digiLED quality just lasts.**



## CONTACT US

### LONDON

UK HEAD OFFICE

The Pixel Depot, Copse Farm, Moorhurst Lane, Beare Green, Surrey RH5 4LJ UK

tel: +44 20 7381 7840 e-mail: [info@digiLED.com](mailto:info@digiLED.com)

 [Sales](#)  [Admin](#)  [Pixel Depot](#)  [Tech Hub](#)  [Service Lab](#)

---

### LAS VEGAS

The Pixel Depot, 365 Pilot Road, Suite A, Las Vegas, Nevada, 89119, USA

tel: +44 20 7381 7840 e-mail: [info@digiLED.com](mailto:info@digiLED.com)

 [Sales](#)  [Admin](#)  [Pixel Depot](#)  [Tech Hub](#)  [Service Lab](#)

---

### DALLAS

digiLED Service Lab, 8291 Gateway Dr, Argyle, TX 76226, USA

 [Service Lab](#)

---

### SHENZHEN

SHENZHEN DIGI TECHNOLOGY CO. LTD,

The Pixel Depot, Room 1807, Haohai Junyue Bldg, 2092 Shenyan Road, Hai Shan Street, Yantian District, Shenzhen 518000, China



 [Tech Hub](#)  [Logistics](#)  [Service Lab](#)

---

### SALES OFFICES IN MILAN, THE HAGUE, NANTES AND TOKYO

### TALK TO US AND BE SOCIAL

+44 20 7381 7840 [info@digiLED.com](mailto:info@digiLED.com) [www.digiLED.com](http://www.digiLED.com)

 [digiLED\\_](#)  [digiLEDscreens](#)  [digiLEDscreens](#)  [digiLED\\_](#)